

Use of Solar Energy in the Automotive Industry

Sepehr Sammak^{1,*}

¹Bachelor of Petroleum Engineering , Islamic Azad university, South Tehran Branch, Tehran, Iran

* Corresponding Author: s.sammak1993@gmail.com,

ABSTRACT

The automotive manufacturing process involves a long and complex supply chain. It includes the production of raw materials (e.g. steel, aluminium, plastic, and glass), fabricated parts, components, and subsystems (internal/external processes); the assembly of these parts, components, and subsystems; and finally the distribution and sale of the vehicles. The sector affects and is affected actively by other energy- intensive industrial sectors, such as steel, glass, and petroleumrelated industries which supply plastic and rubber (for tires production). The economic and environmental concerns for the automotive sector will therefore largely influence these sectors. Energy employed in an automotive plant can be classified as primary and secondary.

Primary energy source use includes electricity and fuel, i.e. 56% and 44% respectively for the automotive OEMs industry in the United States in 2011, for instance. Meanwhile, compressed air, chilled and hot water and steam are examples of secondary energy carriers, which are produced from the primary sources to carry energy throughout the plant. It is worth noting that automotive OEMs tend to adopt different manufacturing processes and materials in practice due to diversity in vehicle models, volumes, availability of external suppliers, energy sources, use of renewable energy, and climate. Due to the extensive consumption of secondary energy carriers, most vehicle manufacturing plants power their production lines by employing an on-site energy conversion and transmission system. Power and steam are usually generated at a central location and then transported to individual facilities for a specific purpose. Meanwhile, systems driven by compressed air and motor (conveyors, material handling, robots, etc.) are usually located closer to consumption.

Keywords: *solar energy, automotive, renewable energy, Energy efficiency*

1. INTRODUCTION

Now, sustainable mobility issues are gaining increasing attention both among specialists and in public opinion, due to the major impact of automotive systems on carbon dioxide production, climate changes and fossil fuel depletion. More in general, there is an increasing awareness about the need to achieve a more sustainable development, allowing meeting the needs of the present without compromising the ability of future generations to meet their needs (Kyoto Protocol, 1997).

With regard to personal mobility issues, the most pressing arguments towards new solutions are the following:

- the CO₂ generated by the combustion processes occurring in conventional thermal engines significantly contributes to the greenhouse effects, with dangerous and maybe dramatic effects on global warming and climatic changes;

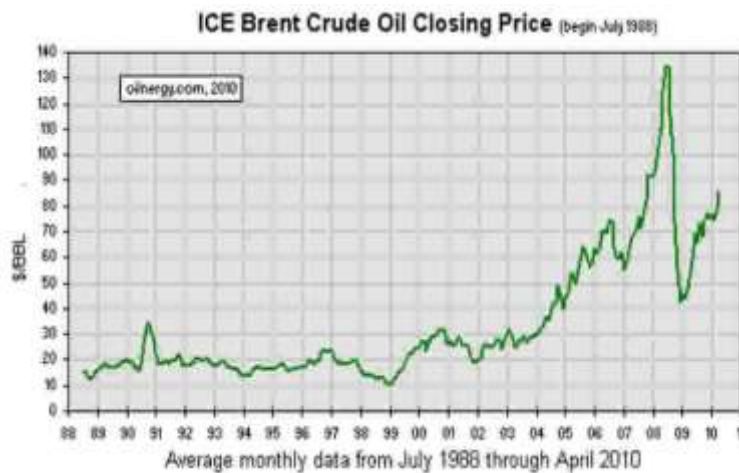

Fig. 1. Trends in oil price (oilnergy.com)

- the worldwide demand for personal mobility is rapidly growing, especially in China and India, where one third of world population lives; as a consequence, energy consumption and CO₂ emissions related to cars and transportation are expected to increase;
- fossil fuels, largely used for car propulsion, are doomed to depletion; their price is still growing, and is subject to large and unpredictable fluctuations (Fig. 1);
- transportation has a marked impact on acoustic and atmospheric pollution in urban areas: consequently, there is an increasing trend to create emissions-free urban areas accessed only by ULEV's (ultra low emissions vehicle) or ZEV's (zero emissions vehicle).

The Kyoto Protocol, and the subsequent decisions taken at various political levels, have emphasized the recourse to renewable energy sources as one of most effective solutions to such problems. Is it therefore natural to wonder about possible use of solar energy for automotive applications.

In a broad sense, all the energy used to fuel the today cars has come from the sun, having been accumulated along millions of years as chemical energy in fossil fuels. But, of course, the growing interest toward solar energy is related to its feature as a renewable source. Also in this sense, solar energy could be used for car propulsion in different ways: i) in indirect way, to

produce bio-fuels (for conventional vehicles) or hydrogen (for fuel-cell vehicles, or vehicles with ICE fueled with hydrogen or a mix of methane and hydrogen); ii) in indirect way, as a renewable source to produce electricity, to recharge Electrical Vehicles (EV) or Hybrid Electric Vehicle (HEV) plug-in; iii) in direct way, by means of photovoltaic panels mounted on the car (the use of thermal panels has not been considered yet for automotive applications: in order to achieve acceptable conversion efficiency, concentrating technologies should be adopted, that seem rather unfeasible in a car).

This paper is mainly focused on direct use of photovoltaic panels on cars, presenting a more detailed and updated survey study with respect to recent papers of the author (Arsie et al., 2006; Rizzo et al., 2010).

2. PHOTOVOLTAIC PANELS: EFFICIENCY AND COST

The conversion from light into direct current electricity is based on the researches performed at the Bell Laboratories in the 50's, where the principle discovered by the French physicist Alexandre-Edmond Becquerel (1820-1891) was applied for the first time. The photovoltaic panels, working thanks to the semiconductive properties of silicon and other materials, were first used for space applications. The diffusion of this technology has been growing exponentially in recent years (Fig. 2), due to the pressing need for a renewable and carbon-free energy (REN21, 2009).

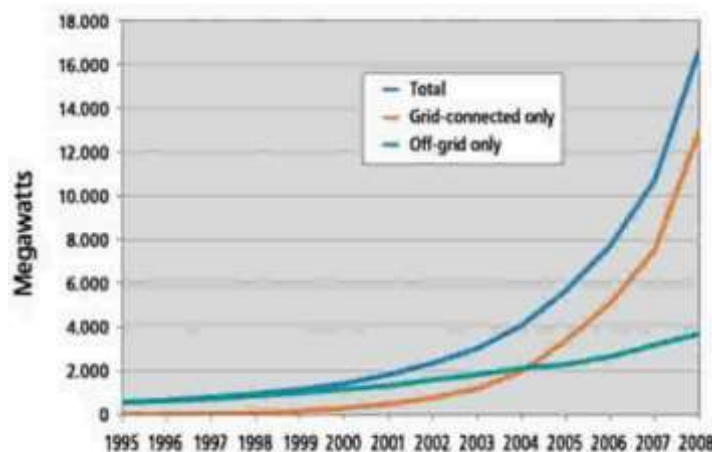

Fig. 2. Solar PV, world capacity 1995-2008(Rizzo.G,2010).

The amount of solar energy is impressive: the 89 petawatts of sunlight reaching the Earth's surface is almost 6,000 times more than the 15 terawatts of average electrical power consumed by humans (Smil, 2006). A pictorial view of the potentialities of photovoltaics is given in Fig. 3, where the areas defined by the dark disks could provide more than the world's total primary energy demand (assuming a conversion efficiency of 8%). The applications range

from power station, satellites, rural electrification, buildings to solar roadways and, of course, transport.

In Fig. 4 the trends for the efficiency of photovoltaic cells are shown. Most of the today PV panels, with multicrystalline silicon technology, have efficiencies between 11% and 18%, while the use of mono-crystalline silicon allows to increase the conversion efficiency of about 4%. The recourse to multijunction cells, with use of materials as Gallium Arsenide (Thilagam et al, 1998), and to concentrating technologies (Segal et al., 2004), has allowed to reach 40% of cell efficiency. Anyway, the cost of these latter solutions is still too high for a mass application on cars.

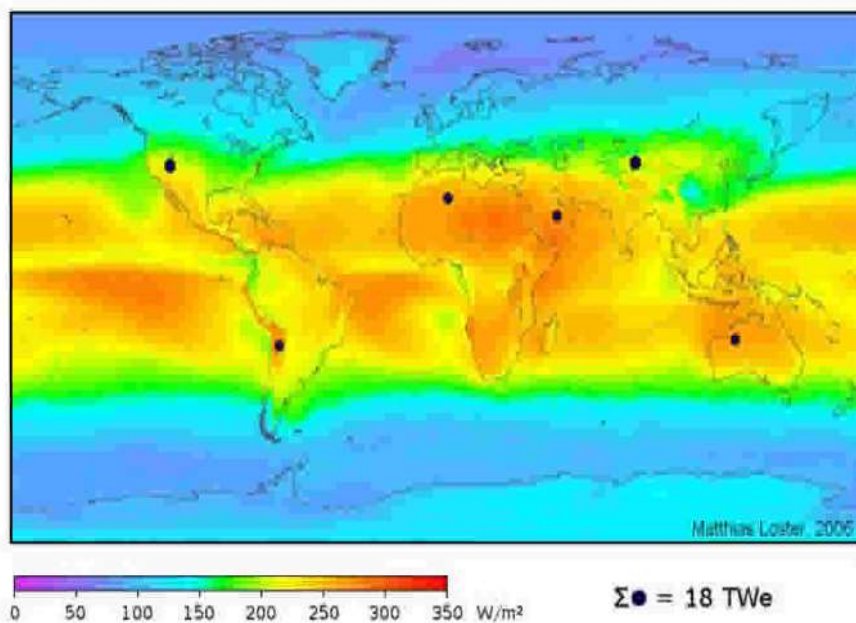

Fig. 3. Average solar irradiance (W/m²) for a horizontal surface (Wikipedia).



Fig. 4. Trends for efficiency of photovoltaic cells(Rizzo.G,2010).

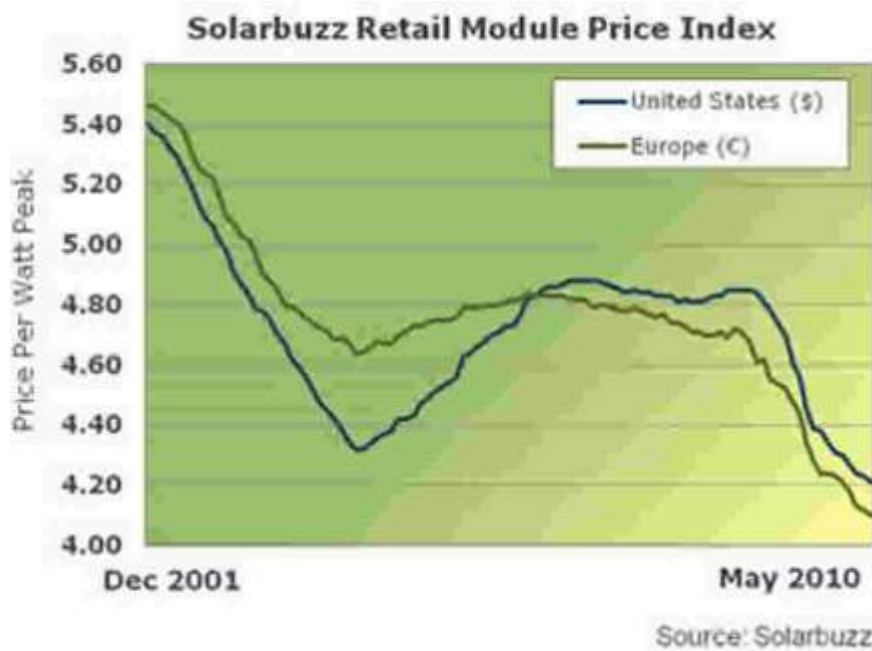

Fig. 5. Trends for cost of photovoltaic modules(Rizzo.G,2010).

About price of solar modules, the market has experienced a long period of falling down of the prices since January 2002 up to May 2004. Afterwards, prices began rising again, until 2006-2007. This inversion has been attributed to the outstripping of global demand with respect

to the supply, so that the manufacturers of the silicon needed for photovoltaic production cannot provide enough raw materials to fill the needs of manufacturing plants capable of increased production (Arsie et al., 2006; see also www.backwoodsolar.com). After 2008, the prices began to fall down again, both in USA and in Europe (Fig. 5).

3. SOLAR ENERGY FOR CARS: PROS AND CONS

The potential advantages of solar energy are clear: it is free, abundant and rather evenly distributed (Fig. 3), more than other energy sources as fossil fuels, uranium, wind and hydro. It has been considered that the solar energy incident on USA in one single day is equivalent to energy consumption of such country for one and half year, and this figure could reach embarrassingly high values in most developing countries.

At the same time, also the limitations of such energy source seem clear: it is intermittent, due to the effects of relative motion between Earth and Sun, and variable in time, due to weather conditions (while the former effect can be predicted precisely, the latter can be foreseen only partially and for short term). But the most serious limitation for direct automotive use concerns its energy density: the amount of radiation theoretically incident on Earth surface is about 1360 W/m² (Quaschnig, 2003) and only a fraction of this energy can be converted as electrical energy to be used for propulsion. Considering that the space available for PV panels on a normal car is limited (from about 1 m² in case of panels outfitting 'normal' cars to about 6 m² for some solar cars), it emerges that the net power achievable by a solar panel is about two orders of magnitude less than the power of most of today's cars.

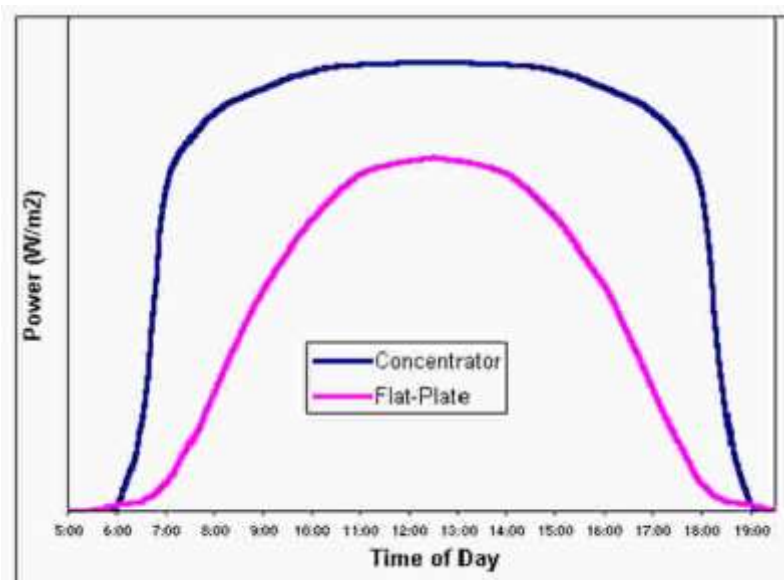

Fig. 6. Solar panel power during a day, for different technologies (Rizzo.G,2010).

But this simple observation, that explains the skepticism about solar energy in most of the automotive community, is based on the misleading habit to think in terms of power, instead of energy. In fact, for a typical use in urban driving (no more than one hour per day, according to recent Statistics for Road Transport, with an average power between 7 and 10 kW, considering a partial recovery of braking energy), the net energy required for traction can be about 8 kWh per day. On the other hand, a PV panel of 300 W of peak power can operate not far from its maximum power for many hours, especially if advanced tracking techniques would be adopted (Fig. 6). In these conditions, the solar contribution can represent a rather significant fraction, up to 20-30%, of the required energy.

The following figure (Fig. 7) shows the average solar contribution as function of number of driving hours h and average traction power, for a vehicle with 3 m² of PV panels @ 24% efficiency in horizontal position (Location: San Antonio, TX). It may be observed that, in case of "continuous" use ($h=10$), the solar energy can completely satisfy the required energy only at very low power (about 1 KW), of course not compatible with "normal" use of a car.

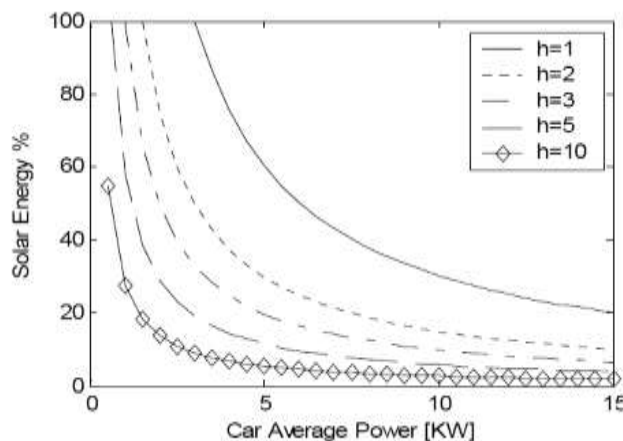

Fig. 7. Solar energy contribution vs. power at different daily driving hours (Rizzo.G,2010).

limited average power, a significant percent, about 20-40%, of the required energy can be provided by the sun (Arsie et al., 2006). It therefore emerges that benefits of solar energy can be maximized when cars are used mostly in urban environment and in intermittent way, spending most of their time parked outdoor, and of course in countries where there is a "sufficient" solar radiation. But, as it will be shown in next chapter, feasible locations are not necessarily limited to "tropical" countries.

EFFECTS OF PANEL POSITION AND USE OF MOVING ROOFS

In most of solar cars, solar panels are fixed and located at almost horizontal position. This solution, although the most practical by several points of view, does not allow to maximize the net power from the sun. In next figure the mean yearly incident energy corresponding to different position of solar panels is presented, for different latitudes. The data have been obtained by PVWatts (<http://www.pvwatts.org/>), based on a database of real data covering

about 30 years, for different locations in USA. It can be observed that, with the adoption of a self-orienting solar roof (2 axis tracking), there is an increase of incident energy, varying from about 800 to 600 kWh/m²/year, from low to high latitudes. In terms of relative gain, a moving panel would increase the solar contribution from about 46%, at low latitudes, up to 78%, at high latitudes. Of course, the adoption of a moving panel could be feasible only for parking phases, where on the other hand many cars in urban environment spend most of their time. The real benefits would be lower than the ones indicated in the graph, due to the energy spent to move the panel and to possible kinematic constraints preventing perfect orientation. Also, in order to maximize the solar contribution, transparent panel could be incorporated in the windows, and the lateral surface of a car could be also covered by solar panels, as for instance in FIAT Phylla (Fig. 21). An estimation of the increase in incident energy can be obtained by considering the mean incident energy on a vertical surface, with random orientation: with respect to the energy incident at horizontal position, their contribution is about 45%, at low latitudes, but up to 65% at higher latitudes.

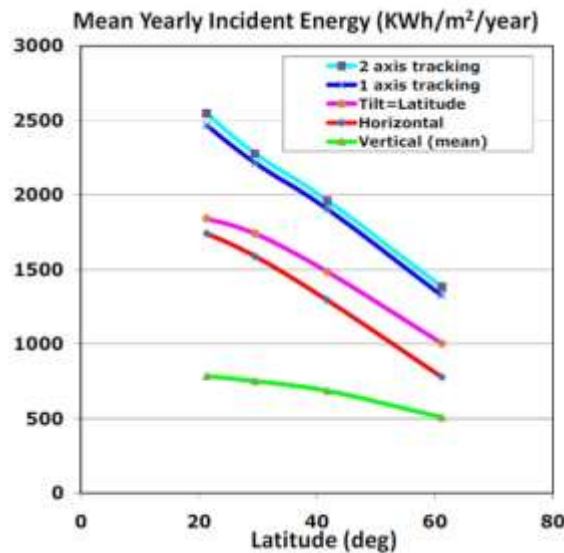

Fig. 8. Effects of panel position and latitude on incident energy(Rizzo.G,2010).

It therefore emerges that the adoption of a moving roof for parking phases, and the utilization of windows and lateral surfaces too, would allow a significant increase of incident energy with respect to the sole utilization of the car roof.

Moreover, this increment is particularly significant at high latitudes, so contributing to enlarge the potential market of solar assisted vehicles.

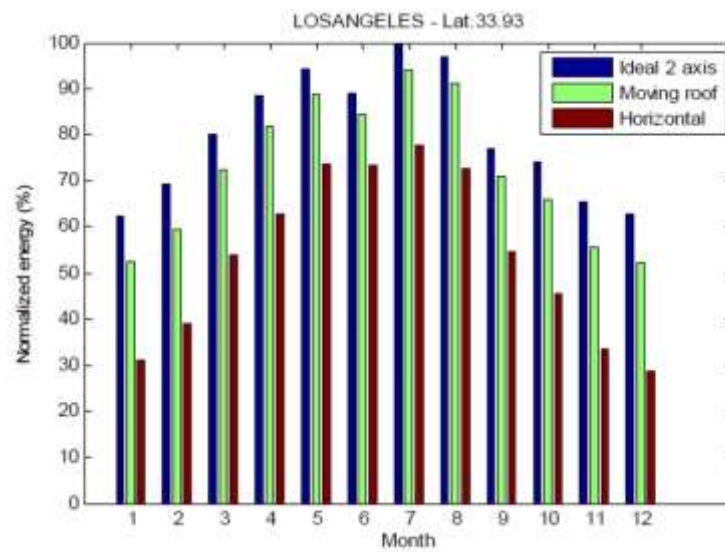

Fig. 9 Energy collected with various options of solar roof (Los Angeles, 1988)

A study on the benefits of a moving solar roof for parking phases in a Hybrid Solar Vehicle has been recently presented (Coraggio et al., 2010). A kinematic model of a parallel robot with three degrees of freedom has been developed and validated over the experimental data obtained by a small scale real prototype. The effects of roof design variables are analyzed, and the benefits in terms of net available energy assessed by simulation over hourly solar data at various months and latitudes (Fig. 9).

4. SOLAR CARS

Several prototypes of solar cars, powered only by the sun, have been built and tested, since '70s. These vehicles were not intended as day-to-day transportation devices, but are rather demonstration vehicles and engineering exercises, also to stimulate students and researchers toward energy saving and automotive applications (Wellington, 1996; Ozawa et al., 1998; Pudney and Howlett, 2002; Gomez de Silva and Svenson, 1993). For these reasons, their development is often sponsored by government agencies.



Fig. 10. A picture of a solar car, developed by Tim Treat, reported by an American newspaper in 1976(Rizzo.G,2010).

Besides some former amateurish prototypes (Fig. 10, Fig.11), a considerable technological effort was spent to build very advanced cars, like Nuna 3 (Fig. 12), developed at the Delft University and winner of World Solar Challenge in 2005, at about 95 km/h of mean speed, and the latest model Nuna 5 (Fig. 13).



Fig. 11. Solectria I, a solar car built by James Worden in 1984(Rizzo.G,2010).



Fig. 12. Nuna 3, developed at Delft University, winner of World Solar Challenge in 2005(Rizzo.G,2010).



Fig. 13. Nuna5, the latest solar car developed at the Delft University(Rizzo.G,2010).

Nuna5 has been further improved in comparison with its predecessors. The top of the car, that weights only 160 kg, is covered with 6 m² of special solar cells. The extra energy is stored in a battery, for use when overtaking or in cloudy weather. Moreover, due to new racing rules, this model adopted tyres with a proper tread like those of normal cars, resulting in extra rolling friction.

World Solar Challenge, where the solar car race across the Australia for 3000 km, is one the most famous events in this category, attracting competitors from around the world (www.wsc.org.au). Another notable solar car race is the North American Solar Challenge (the most recent ran from August 13–21, 2008, from Dallas, Texas to Calgary, Alberta). The technological effort spent on solar cars has led during the years to relevant advances in their technology: in last editions of North American Solar Challenge, the organizers have been driven to change the rules of the racing, in order to avoid that the teams may overcome the regulated speed limits. But, in spite of these spectacular advances, the high costs, the need of minimizing weight, friction and aerodynamic losses and the absence, in most cases, of a storage system of adequate capacity able to assure a regular operation without solar radiation make these vehicles quite different from the current idea of car.

5. SOLAR ENERGY AND FLEET ELECTRIFICATION

Besides the studies on solar cars, powered only by sun, the perspectives of diffusion of photovoltaic to cars are strongly related to the degree of electrification of the fleet, intended as the relative capacity of delivering torque to or receiving torque from the powertrain. The presence of different kind of vehicles using electric propulsion is now relatively limited in terms of fleet distribution (Fig. 14), but it expected to increase substantially in next decades (Fig. 15), according to recent studies (Fisher, 2009).

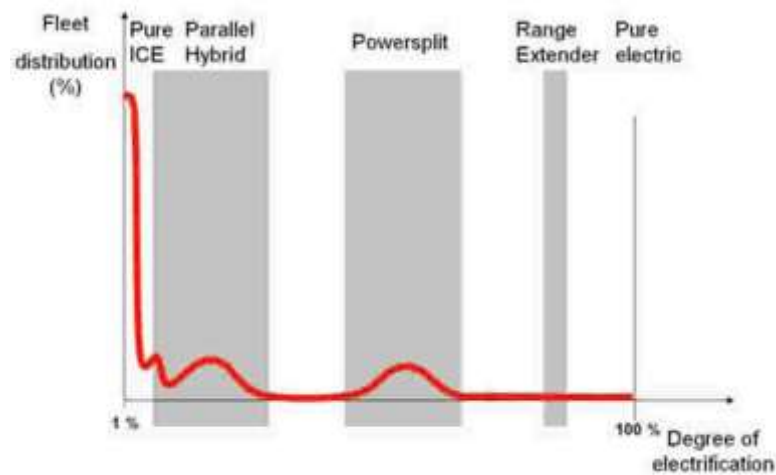

Fig. 14. Degree of Electrification – Near Term Expectations(Rizzo.G,2010).

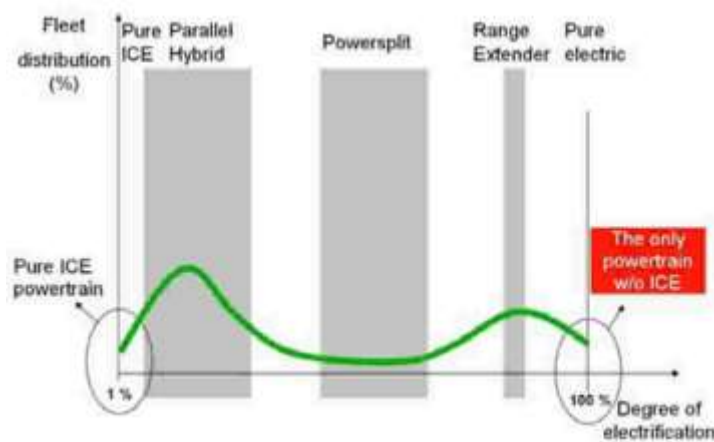

Fig. 15. Degree of electrification. Vision 2025(Rizzo.G,2010).

Solar energy could in principle be applied to all the categories listed in the study: Electric Hybrid, Powersplit, Range Extender and Pure Electric. In all the cases, the relevance of solar contribution is related to the possibility to accumulate the solar energy during the parking period, and is therefore also related to the presence of a battery of adequate capacity. In that sense, the critical aspects related to battery technology are reflected in limitations for automotive applications of solar energy. As it is known, the capillary distribution network and the high energy density of liquid fuels, assuring a vehicle range up to 1000 km, have represented the most real competitive advantage of conventional vehicles over electrical vehicles, and an obstacle to the diffusion of these latter. In fact, conventional lead-acid batteries energy density is about two orders of magnitude lower than liquid fuels (www.electricitystorage.org). But in last decade the picture has changed, and, thanks to the

advances in Lithium-Ion technology, the gap has been reduced (Tab. 1), while further progresses seem possible by adopting innovative nanocomposite materials for such batteries (Magasinki et al., 2010).

Tab. 1 – Output energy density comparison. (*) Average conversion efficiency of 25% considered for liquid fuels(Rizzo.G,2010).

	kWh/ton	%	kWh/m ³	%
Liquid Fuel(*)	2.917	100,00	3.889	100,00
Lead-Acid	30	1,03	50	1,29
Li-Ion	130	4,46	350	9,00

While it is unlikely that batteries could reach or exceed in the near future the energy density of liquid fuels, it should be considered that the range of today cars is somewhat redundant. The picture in Fig. 16 shows the places that could be reached by Munich by travelling (in straight line) for 1.000 km, spanning several European countries. Furthermore, considering the actual distribution of gas stations in Europe, something like 100.000 gas pumps would be contained in a circle of 1.000 km radius.



Fig. 16. Range of 1000 km around Munich, Germany(Rizzo.G,2010).

A such large range is certainly convenient, but one may wonder if it is strictly necessary for a car, at least for those travelling in advanced countries. But electric vehicles are also penalized by the longer recharging time with respect to conventional vehicles and by the need of a diffuse network for recharging stations. In this respect, the possibility of recharging the

batteries from the sun for free and without the need to be connected to the grid surely contributes to overcome one of the critical issues related to fleet electrification.

Solar energy and V2G technology

Moreover, the presence of a photovoltaic panel on a Plug-in Hybrid Electric Vehicle (PHEV) can enhance the development of Vehicle to Grid (V2G) technology: in this approach, the plug-in vehicles, besides receiving power when parked, can also provide power to the grid. The V2G capable vehicle must have three required elements: (1) a connection to the grid for electrical energy flow, (2) control or logical connection necessary for communication with the grid operator, and (3) controls and metering on-board the vehicle (Arsie et al., 2009). Use of PHEV for V2G can provide benefits to both vehicle owner and the power utility company, apart from the reduced tailpipe emissions and increased mileage. Statistical analysis suggest that the use of PHEV to supply energy to the grid is beneficial when the number of vehicle connected to the grid is large (Kempton et al., 2001). This technology is now spreading: on September 2009, Delaware's Governor signed a law on V2G, requiring electric utilities to compensate owners of electric cars for electricity sent back to the grid at the same rate they pay for electricity to charge the battery (www.udel.edu/V2G/).

In this context, it is clear that a solar powered PHEV can contribute to power the grid also using solar energy, that is free and renewable. This opportunity prevents also to waste solar energy provided by PV panels on the car when car batteries are fully charged.

6. ELECTRIC AND HYBRID SOLAR VEHICLES

The interest toward Hybrid Solar Vehicles (HSV) and Vehicle Integrated Photo Voltaic (VIPV) has been growing in recent years due to the industrial and commercial success of hybrid vehicles and to the diffusion of PV sources. The attention to hybrid solar vehicles dates to the 90's, when some pioneering prototypical applications appeared. An innovative vehicle (Viking 23, Fig. 17) has been developed at Western Washington University (Seal and Campbell, 1995), adopting advanced solutions for materials, aerodynamic drag reduction and PV power maximization with peak power tracking.



Fig. 17. Viking 23, developed at Western Washington University(Rizzo.G,2010).

Another study on a solar hybrid vehicle has been presented by Japanese researchers (Saitoh et al., 1992), with PV panels located on the roof and on the windows of the car. A further prototype of solar hybrid car powered with a gasoline engine and an electric engine has been tested by Sasaki et al. (1997).

In this case, a relevant amount of the solar energy was provided by PV panels located at the parking place, while only a small fraction was supplied by PV panels on the car. An advanced prototype (Ultra Commuter) has been developed at the Queensland University, adopting a hybrid series structure (Simpson et al., 2002). The Canadian engineer Steve Lapp applied 270 W PV panels over a Toyota Prius, achieving a 10% savings in fuel consumption with respect to the original hybrid vehicle (www.lapprenewables.com).

FIAT has recently presented Phylla, a small electric city-car assisted by PV panels, mounted also on car doors (Fig. 21), and adopting in-wheel motors. The French company Venturi has realized in last years different concept cars, as Venturi Eclectic (Fig. 18) and Venturi Astrolab (Fig. 19), presented as the first hybrid solar vehicle in sale. Recently, a model of Toyota Prius integrated with a solar panel has been produced (Fig. 20). In this case, the solar energy is used to power the air conditioning system.

A wide overview over the Vehicle Integrated Photo Voltaic (VIPV) is reported by Letendre et al. (2003). The opportunities offered by the integration of electric vehicles with grid and stationary systems are remarked (Vehicles connected To Grid, V2G; Plug-in Hybrid Electric Vehicle, PHEV). A radio controlled system already available in California could allow to charge and draw power from parked EV. Moreover, the author remarks that the battery pack of parked EV or HEV can enhance the capabilities of stationary photovoltaic installations.



Fig. 18. Venturi Eclectic Concept Car(Rizzo.G,2010).



Fig. 19. Astrolab Venturi(Rizzo.G,2010).



Fig. 20. Toyota Prius Solar(Rizzo.G,2010).

According to some recent studies (Neil C., 2006), PV panels added to hybrid cars could be even more cost effective than PV panels added to buildings. The incremental cost of solar PV panels on hybrid cars and displacing gasoline could have a payback period much shorter than the payback for solar PV panels on buildings and displacing electricity. This result has been also confirmed by some evaluations recently made by the author, aimed to the estimation of pay-back time of moving and fixed solar roofs for a PV assisted vehicle at different latitudes (Coraggio et al., 2010).



Fig. 21. The FIAT Phylla (Rizzo.G,2010).

7. RESEARCH ISSUES RELATED TO AUTOMOTIVE APPLICATIONS OF PHOTOVOLTAIC

There are several research issues related to the application of PV panels on cars. PV panels can be added to a car just to power some accessories, as ventilation or air conditioner, or to contribute to car propulsion. Particularly in this latter case, it would be simplistic to consider their integration as the sole addition of photovoltaic panels to an existing vehicle. In fact, the development of HEV's, despite it was based on well-established technologies, has shown how considerable research efforts were required for both optimizing the powertrain

design and defining the most suitable control and energy-management strategies. Analogously, to maximize the benefits coming from the integration of photovoltaic with HEV technology, it is required performing accurate redesign and optimization of the whole vehicle-powertrain system, considering the interactions between energy flows, propulsion system component sizing, vehicle dimension, performance, weight and costs. In the following, some of these aspects are described, also based on the author's direct experience on Hybrid Solar Vehicles.

8. SOLAR PANEL CONTROL

The surface of solar panels on a car is limited, with respect to most stationary applications. It is therefore important to maximize their power extraction, by analyzing and solving the problems that could reduce their efficiency. Part of these aspects are common to the stationary plants also, but some of them are quite specific of automotive applications. For example, the need of connecting cells of different types (technology as well as electrical and manufacturing characteristics) within the same array usually leads to mismatching conditions. This may be the case of using standard photovoltaic cells for the roof and transparent ones, in place of glasses, connected in series. Again, even small differences among the angles of incidence of the solar radiation concerning different cells/panels that compose the panel/string may cause a mismatching effect that greatly affects the resulting photovoltaic generator overall efficiency.

Such reduction may become more significant at high cell temperatures, with a de-rating of about 0.5%/°C for crystalline cells and about 0.2%/°C for amorphous silicon cells (Gregg, 2005). These effects are more likely in a car, due to the exigency to cover a curved surface, where differences in solar radiation and temperature can be higher than in a stationary plant. All these aspects are of course enhanced and complicated during driving, due to orientation changes and shadows. In the photovoltaic plants it is mandatory to match the PV source with the load/battery/grid in order to draw the maximum power at the current solar irradiance level.

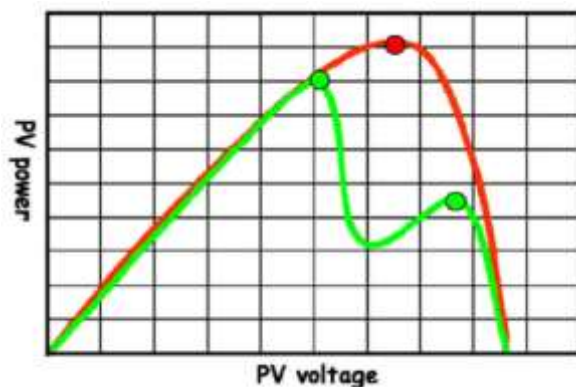

Fig. 22. Power vs. voltage characteristic of a PV field under uniform conditions (red) and with mismatching (green) (Rizzo.G,2010).

To this regard, a switching dc-dc converter controlled by means of a Maximum Power Point Tracking (MPPT) strategy is used (Hohm, 2000) to ensure the source-load matching by properly changing the operating voltage at the PV array terminals in function of the actual conditions. Usually, MPPT strategies derived by the basic Perturb and Observe (P&O) approach are able to detect the unique peak of the power vs. voltage characteristic of the PV array, in presence of uniform irradiance (Fig. 22, red curve). But, due to mismatching and non uniform irradiation, temperature distribution and manufacturing features, the shape of the PV characteristic may exhibit more than one peak (Fig. 22, green curve). In these cases, the standard MTPP techniques tend to fail, so causing a reduction in power extraction (Egiziano et al., 2007; Femia et al., 2008). More advanced approaches, based on a detailed modelling of the PV field and on numerical techniques, have been developed to face with this problem (Jain, 2006; Liu, 2002).

9. POWER ELECTRONICS

In a solar assisted electric or hybrid vehicle, particular attention must be spent on power electronics, to enable better utilization of energy sources. To this purpose, high efficiency converter topologies, with different system configurations and particular control algorithms, are needed (Kassakian, 2000; Cacciato et al., 2004).

The use of multi-converters configurations could be advisable to solve the problems of solar generators such as PV modules mismatching and partial shadowing. A comparative study of three different configurations for a hybrid solar vehicle has been recently presented (Arsie et al., 2006, Cacciato et al., 2007). In order to reduce power devices losses, the increase of converter switching frequencies by adoption of softswitching topologies is also considered. The advantages consist in reducing the size of the passive components and, consequently, the converter weight and volume while decrease the overall Electro Magnetic Interference (EMI), a critical point in automotive applications. Moreover, the converters can be designed by adopting recent technologies such as planar magnetic structures and SMD components, in order to allow the converters to be located inside the photovoltaic modules.

10. OPTIMAL DESIGN OF HYBRID SOLAR VEHICLES

Despite their potential interest, solar hybrid cars have received relatively little attention in literature until a few of years ago (Letendre et al., 2003), particularly if compared with the great effort spent in last years toward other solutions, as hydrogen cars, whose perspectives are affected by critical issues regard to hydrogen production, distribution and storage. A study on the optimal design of a Hybrid Solar Vehicle has been performed at the University of Salerno, considering performance, fuel consumption, weight and costs of the components (Arsie et al., 2007, 2008). The study, that has determined optimal vehicle dimensions and powertrain sizing for various scenarios, has shown that economic feasibility (pay-back between 2 and 3 years) could be achieved in a medium term scenario, with mild assumptions in terms of fuel price increase, PV efficiency improvement and PV cost reduction.

A prototype of HSV with series structure (Fig. 23) has also been developed (Adinolfi et al., 2008), within the framework on an educational project funded by EU (Leonardo project

I05/B/P/PP-154181 “Energy Conversion Systems and Their Environmental Impact, www.dimec.unisa.it/Leonardo).



Fig. 23. A prototype of Hybrid Solar Vehicle with series structure developed at the University of Salerno(Rizzo.G,2010).

While the actual prototype (HSV-A, Fig. 24) is penalized by a non optimal choice of their components, also due to budget limitations, the simulation model validated over the prototype data shows that very interesting values of fuel economy could be reached by improving the efficiency of solar panels (from 12% to 18%) and optimizing battery capacity and weight (HSV-B), and further reducing vehicle weight by adoption of Lithium-Ion batteries instead of original Lead-Acid (HSV-C).

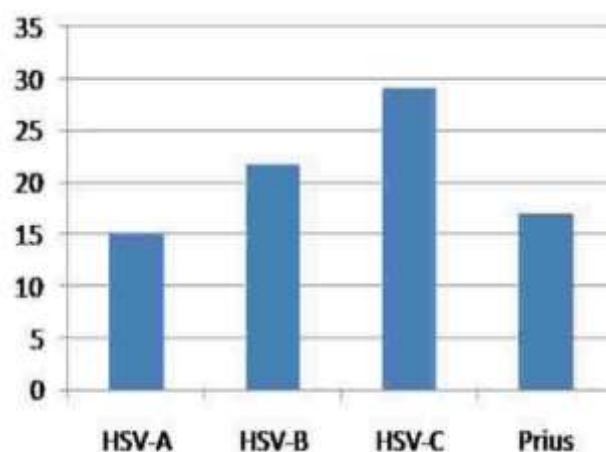

Fig. 24. Fuel Economy (km/l) on ECE Cycle - HSV vs. Toyota Prius. A – actual prototype. B – PV eff.=18% - Batt.=75 Ah. C – B+ 20% weight off – Lithium-Ion Batt(Rizzo.G,2010).

11. MANAGEMENT AND CONTROL OF ENERGY FLOWS

The energy management of Hybrid Solar Vehicles, in spite of many similarities with HEV's, could not simply be borrowed from the solutions developed for HEV's: in fact, while in these latter a charge sustaining strategy is usually adopted, in HSV's the battery can be recharged also during parking time by solar energy, and therefore a charge depletion strategy has to be followed during driving, as it happens for Plug-In Hybrid Electric Vehicles (PHEV) (Marano et al., 2009). Anyway, there are again some differences between PHEV and HSV: while for PHEV the recharge is mainly finalized to extend the vehicle range, for HSV's the input energy is free, and solar recharge should be maximized not only to extend the range, but mainly to minimize fuel consumption and CO₂ emissions. Therefore, at the end of driving cycle the final state of charge (SOC) should be sufficiently low to leave room for the solar energy to be stored in the battery in the next parking phase. On the other hand, the adoption of an unnecessary low value of final SOC could produce additional energy losses associated to battery operation, so increasing fuel consumption.

In a recent paper (Rizzo and Sorrentino, 2010), the effects of different strategies of selection of final SOC are studied by simulation over hourly solar data at different months and locations, and the benefits achievable by estimating the energy expected in next parking phase are assessed. The simulations are carried out with a dynamic model of a HSV previously developed (Arsie et al., 2007), including a rulebased (RB) energy management strategy. The results have shown that the estimation of the incoming solar energy in next parking phase produces a more efficient energy management, with reduction in fuel consumption, particularly at higher insulation.

The RB control architecture consists of two loops: i) an external loop, defining the desired final state of charge to be reached at the end of the driving cycle; ii) an internal loop, estimating the average power delivered by the internal combustion engine and SOC deviation. The results of RB strategy have been successfully compared with a benchmark (non implementable) strategy, obtained by means of a Genetic Algorithm (Sorrentino et al., 2009). In the study, a vehicle dynamic model considering also the effects of engine thermal transients on fuel consumption and power, related to start-stop operation, has been adopted. The importance of thermal transients in start-stop operation over fuel consumption and emissions, neglected in most models used for energy management in hybrid vehicles, has been also demonstrated by recent experimental studies (Ohn et al., 2008).

A method for fuel consumption minimization in a Hybrid Solar Vehicle based on application of Model Predictive Control has also been recently proposed (Preitl et al., 2007).

12. UPGRADE OF CONVENTIONAL VEHICLES

A possible remark is that, considering the current economic crisis, it is unlikely that, in next few years, PV assisted EV's and HEV's will substitute for a substantial number of conventional vehicles, since relevant investments on production plants would be needed. This fact would of course impair the global impact of this innovation on fuel consumption and CO₂ emissions, at least in a short term scenario. Therefore, one may wonder if there is any possibility to upgrade conventional vehicles to PV assisted hybrid. A proposal of a kit to be distributed in after-market has been recently formulated and patented by the author

(www.hysolarakit.com). Mild-solar-hybridization will be performed by installing in-wheel electric motors on the rear wheels (in case of front wheel drive) and by the integration of photovoltaic panels on the roof. The original architecture will be upgraded with the an additional battery pack and a control unit to be faced with the engine management system by the OBD port. The Vehicle Management Unit (VMU), which would implement control logics compatible with typical drive styles of conventional-car users, receives the data from OBD gate and battery (SOC estimation) and drives in-wheel motors by properly acting on the electric node EN (Fig. 25). A display on the dashboard may advice the driver about the actual operation of the system. The project has been recently financed by the Italian ministry of research (www.dimec.unisa.it/PRIN/PRIN_2008.htm). The results will be published shortly, and presented on the cited websites.

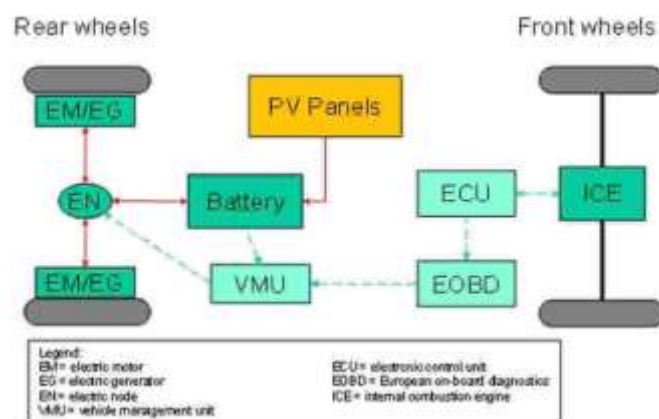

Fig. 25. Scheme of a system to upgrade a conventional car to Mild Hybrid Solar Vehicle(Rizzo.G,2010).

The use of solar energy for personal mobility seems ripe for passing from prototypical applications to commercial products. The integration of photovoltaic panels in electric and hybrid vehicles is becoming more feasible, due to the increasing fleet electrification, to the increase in fuel costs, to the advances in terms of PV panel technology, and to the reduction in their cost. Hybrid Solar Vehicles may therefore represent a valuable solution to face both energy saving and environmental issues. Of course, these vehicles cannot represent a universal solution, since the best balance between benefits and costs would depend on mission profile: in particular, significant reductions in fuel consumption and emissions can be obtained during typical use in urban conditions during working days. Moreover, the integration with solar energy would also contribute to reduce battery recharging time, a critical issue for Plug-in vehicles, and to add value for Vehicle to Grid applications. Putting a solar panel on an existing hybrid vehicle may be just the first step: in order to maximize their benefits, redesign and optimization of the whole vehicle-powertrain system would be required. Particular attention has to be paid in maximizing the net power from solar panels, and in adopting advanced solutions for power electronics.

Moreover, these vehicle would require specific solutions for energy management and control, whit more advanced lookahead capabilities. The adoption of moving roofs for parking phases and the use of solar panels on windows and lateral sides would enhance solar contribution, beyond the classical fixed panel on the car roof. Moreover, these solutions would reduce the gap between solar contribution at low and high latitudes, so extending the potential market of these vehicles. Interesting opportunities are also related to possible reconversion of conventional vehicles to Mild Hybrid Solar Vehicles, by means of kits to be distributed in after-market.

The perspectives about cost issues of PV assisted vehicles are encouraging. Anyway, as it happens for many innovations, full economic feasibility could not be immediate, and a financial support from governments would certainly be appropriate. But the recent and somewhat unexpected commercial success of some electrical hybrid cars indicates that there are grounds for hope that a significant number of users is already willing to spend some more money to contribute to save the planet from pollution, climate changes and resource depletion.

REFERENCES

Adinolfi G., Arsie I., Di Martino R., Giustiniani A., Petrone G., Rizzo G., Sorrentino M., (2008) , “A Prototype of Hybrid Solar Vehicle: Simulations and On-Board Measurements”, Proc.of Advanced Vehicle Control Symposium AVEC 2008, October 6-9, 2008, Kobe (Japan) 917-922 Society of Automotive Engineers of Japan - ISBN: 978-4-904056-21-9

Arsie I., Cacciato M., Consoli A., Petrone G., Rizzo G., Sorrentino M., Spagnuolo G., (2006), “Hybrid Vehicles and Solar Energy: a Possible Marriage?”, International Conference on Automotive Technologies ICAT 2006, November 17-18, 2006, Istanbul.

Arsie I., Marano V., Moran M., Rizzo G. (2009), “Potentialities of CAES and V2G in the Electricity Market Optimization and in the Integration of Renewable Resources”, 2nd Power Make Up Conference POMAC 2009, 15-17 November 2009, Marriot Courtyard Hotel, Kuwait.

Arsie I., Rizzo G., Sorrentino M. (2007), “Optimal Design and Dynamic Simulation of a Hybrid Solar Vehicle”, SAE TRANSACTIONS - Journal of Engines, Vol. 115-3 (2007), pp. 805-811.

Arsie I., Rizzo G., Sorrentino M. (2008), “A Model for the Optimal Design of a Hybrid Solar Vehicle”, Review of Automotive Engineering, Society of Automotive Engineers of Japan (JSAE), 2008, ISSN 1349-4724. 29-3: 439-447

Cacciato M., Consoli A., Scarcella G., Testa A. (2004), “A Multhi-Phase DC/DC Converter for Automotive Dualvoltage Power Systems” IEEE Industry Applications Magazine, November/December 2004, pp. 2-9.

Cacciato M., Consoli A, Scarcella G, Scelba G. (2007), Accurate Implementation of a State of Charge Estimator for Hybrid and Elecric Vehicle Battery Packs. 2nd International Workshop on Hybrid Vehicles. 14 September, 2007. (pp. 1-6). Salerno, Italy.

Egiziano L., Giustiniani A., Lisi G., Petrone G., Spagnuolo G., Vitelli M.(2007): “Experimental characterization of the photovoltaic generator for hybrid solar vehicle”. Proc of 2007 IEEE International Symposium on Industrial Electronics, June 4-7 2007 Vigo (Spain), pp 329-334.

ESA, Electricity Storage Association, www.electricitystorage.org

Femia N., Lisi G., Petrone G., Spagnuolo G., Vitelli M. (2008), “Analysis of Photovoltaic Systems with Distributed Maximum Power Point Tracking”, Proc. Of IEEE International Symposium on Industrial Electronics ISIE08, June 30-July 2 2008 pp. 2408 - 2413.

Fischer R. (2009), The Electrification of the Powertrain – from Turbohybrid to Range Extender, 30. Internationales Wiener Motorensymposium 2009.

Gomez de Silva, J.; Svenson, R. (1993), Tonatiuh, the Mexican Solar Race Car. A vehicle for technology transfer. SAE Special Publications n 984 1993, p 63-67 931797.

Hohm, D.P.; Ropp, M.E., (2000), “Comparative study of maximum power point tracking algorithms using an experimental, programmable, maximum power point tracking test bed”, Conference Record of the Twenty- Eighth IEEE Photovoltaic Specialists Conference, 2000. 15-22 Sept. 2000, pp:1699 – 1702

Kassakian, J.G. (2000), Automotive Electronics Power Up IEEE Spectrum, Volume : 37, Issue : 5 May 2000, Pages:34 – 39

Kempton W., Tomić J., Letendre S., Brooks A., Lipman T. (2001), “Vehicle-to-Grid Power: Battery, Hybrid, and Fuel Cell Vehicles as Resources for Distributed Electric Power in California”, Report prepared for California Air Resources Board and the California Environmental Protection Agency, 2001.

Kyoto Protocol: Status of Ratification. United Nations Framework Convention on Climate Change (2008-10-16),http://unfccc.int/files/kyoto_protocol/status_of_ratification/application/pdf/kp_ratification.pdf

Jain, A.; Sharma, S.; Kapoor, A., (2006), “Solar cell array parameters using Lambert W-function”, Solar Energy Materials & Solar Cells 90 (2006) 25–31

Leonardo Project I/05/B/F/PP-154181, "Energy Conversion Systems and Their Environmental Impact", <http://www.dimec.unisa.it/Leonardo>

Letendre S., Perez R., Herig C. (2003), Vehicle Integrated PV: A Clean and Secure Fuel for Hybrid Electric Vehicles, Proc. of the American Solar Energy Society Solar 2003 Conference, June 21-23, 2003, Austin, TX.

Liu, S., Dougal, R.A. (2002), "Dynamic multiphysics model for solar array", IEEE Trans. On Energy Conversion, Vol. 17, No. 2, June 2002, pp. 285-294.

Luque A., Hegedus S., (2003). Handbook of Photovoltaic Science and Engineering. John Wiley and Sons. ISBN0471491969.

Magasinki A., Dixon P., Hertzberg B., Kvit A., Ayala J., Yushin G. (2010), “High-performance lithium-ion anodes using a hierarchical bottom-up approach”. Nature Materials, 2010; DOI: 10.1038/nmat2725

Marano V., Tulpule P., Stockar S., Onori S., Rizzoni G. (2009), “Comparative study of different control strategies for Plug-In Hybrid Electric Vehicles”. SAE Paper 2009-24-0071, 9th International Conference on Engines and Vehicles (ICE 2009), Sep 13-18, 2009, Capri (Italy).

Ohn H., Yu S., Min K.D. (2008), “Effects of Spark Ignition Timing and Fuel Injection Strategy for Combustion Stability on HEV Powertrain During Engine Restart and Deceleration Driving”, Proc. of IFAC World Congress 2008, July 6-11, Seoul (South Korea), pp. 5658-5663.

Ozawa H., Nishikawa S., Higashida D. (1998), Development of Aerodynamics for a Solar Race Car, JSAE Review 19 (1998) 343–349.

Neil C. (2006), Solar Hybrid Vehicle, http://www.energypulse.net/centers/article/article_display.cfm?a_id=1267

Preitl Z., Bauer P., Kulcsar B., Rizzo G., Bokor J. (2007) Control Solutions for Hybrid Solar Vehicle Fuel Consumption Minimization In: Proceedings of the 2007 IEEE Intelligent Vehicles Symposium, Istanbul, Turkey, June 13-15, 2007.

Pudney P., Howlett P. (2002), Critical Speed Control of a Solar Car, Optimization and Engineering, 3, 97–107, 2002.

Quaschnig V. (2003), "Technology fundamentals - The sun as an energy resource". Renewable Energy World 6 (5):90–93.

REN21, Renewables - Global Status Report - 2009 Update, http://www.ren21.net/pdf/RE_GSR_2009_update.pdf

Rizzo G., Arsie I., Sorrentino M. (2010), Solar energy for cars: perspectives, opportunities and problems, GTAA Meeting, Université de Mulhouse, May 26-27, 2010.

Rizzo G., Sorrentino M. (2010), “Introducing Sunshine Forecast to Improve On-Board Energy Management of Hybrid Solar Vehicles”, IFAC Symposium Advances in Automotive Control, July 12 - 14 2010, Munich, Germany.

Sciarretta A., Guzzella L., “Control of Hybrid Electric Vehicles”. IEEE Control Systems Magazine, Vol. 27(2007), No. 2, pp. 60-70.

Seal M.R., Campbell G. (1995), Ground-up hybrid vehicle program at the vehicle research institute. Electric and Hybrid Vehicles - Implementation of Technology SAE Special Publications n 1105 1995.SAE, Warrendale, PA, USA.p 59-65.

Segal A., Epstein M., Yogev A., (2004), Hybrid concentrated photovoltaic and thermal power conversion at different spectral bands, *Solar Energy* 76 (2004) 591–601

Smil V., (2006), Energy at the Crossroads, Global Science Forum Conference on Scientific Challenges for Energy Research, Paris, May 17-18, 2006

Sorrentino M., Rizzo G., Arsie I. (2009), Analysis of a Rule- Based Control Strategy for On-Board Energy Management of Hybrid Solar Vehicles, ECosm'09 - IFAC Workshop on Engine and Powertrain Control, Simulation and Modeling, Nov.30-Dec.2, 2009, IFP, Rueil-Malmaison, France

The PVWatts Solar Calculator, <http://www.pvwatts.org/>

Thilagam, A., Singh, J., Stulik, P., (1998), Optimizing Gallium Arsenide multiple quantum wells as highperformance photovoltaic devices, *Solar Energy Materials and Solar Cells*, Vol: 50, 1-4, January, 1998 pp. 243-249, Elsevier

Wellington R.P. (1996), Model Solar Vehicles Provide Motivation for School Students, *Solar Energy* Vol.58, N.1-3.

Rizzo,G.,” Automotive Applications of Solar Energy”, 6th IFAC Symposium Advances in Automotive Control Munich, Germany, July 12-14, 2010 .

Wikipedia, en.wikipedia.org/wiki/Photovoltaics

World Solar Challenge, www.wsc.org.au